

Einbruchsicherung

Name: _____ Klasse: _____

www.elimitron.de

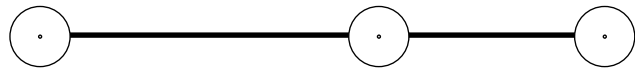

+

A



-

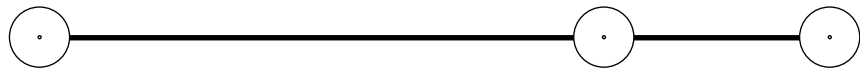

B



Passend zu Best.Nr. 10-801, 11-801, 12-801

Sensortaste

Name: _____ Klasse: _____

www.elmitron.de

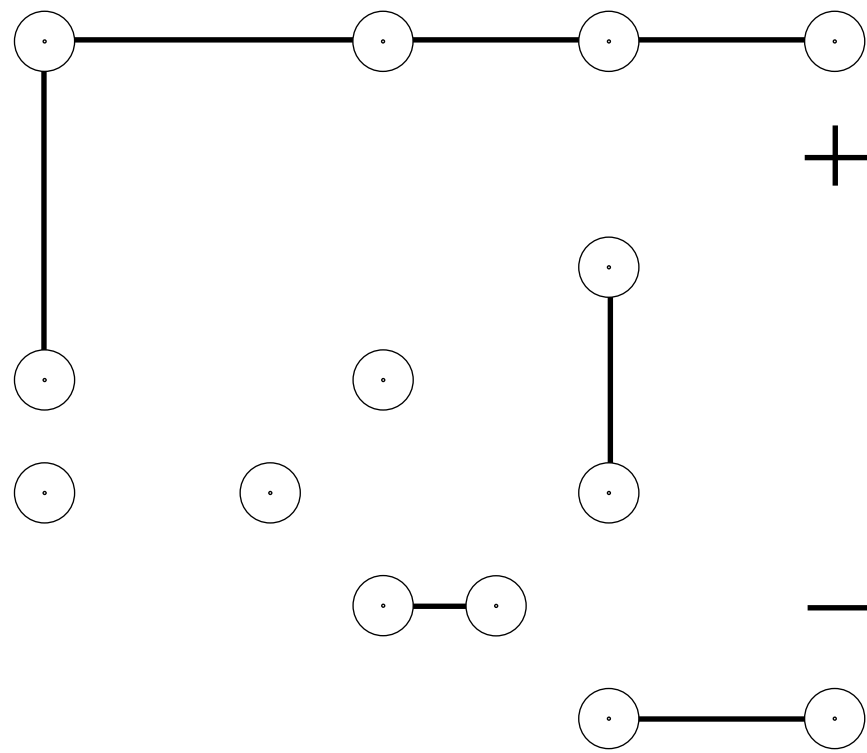

Passend zu Best.Nr. 10-802, 11-802, 12-802

Lichtschanke

Name: _____ Klasse: _____

www.elmitron.de

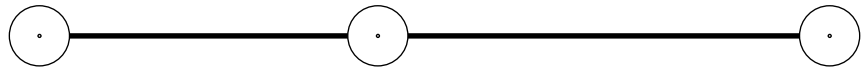

+

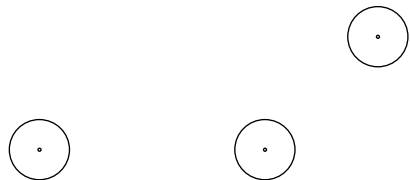

-



Passend zu Best.Nr. 10-803, 11-803, 12-803

Feuchtigkeitsmelder

Name: _____ Klasse: _____

www.elmitron.de



+

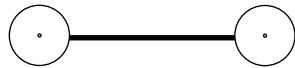
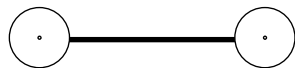

-

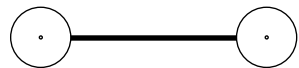

Passend zu Best.Nr. 10-804, 11-804, 12-804

Wechselblinker

Name: _____ Klasse: _____

www.elmitron.de



+

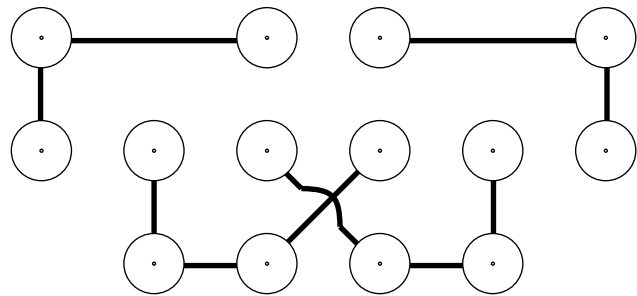

-



Passend zu Best.Nr. 10-805, 11-805, 12-805

Blinklicht

Name: _____ Klasse: _____

www.elmitron.de

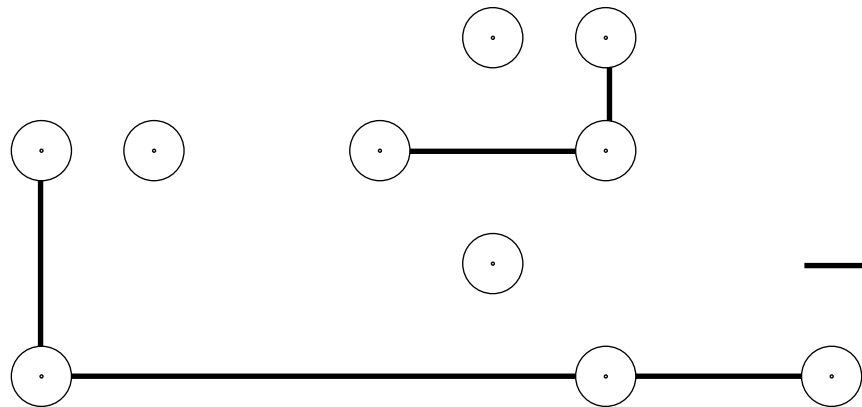
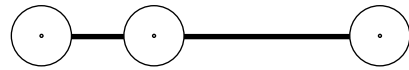
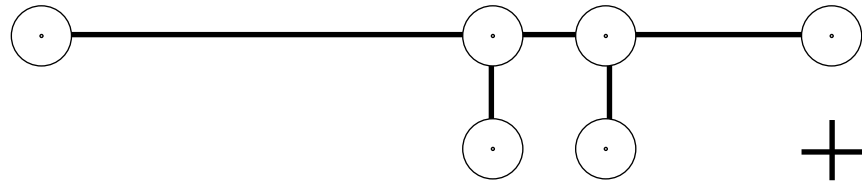

Passend zu Best.Nr. 10-806, 11-806, 12-806

Zeitschalter

Name: _____ Klasse: _____

www.elmitron.de

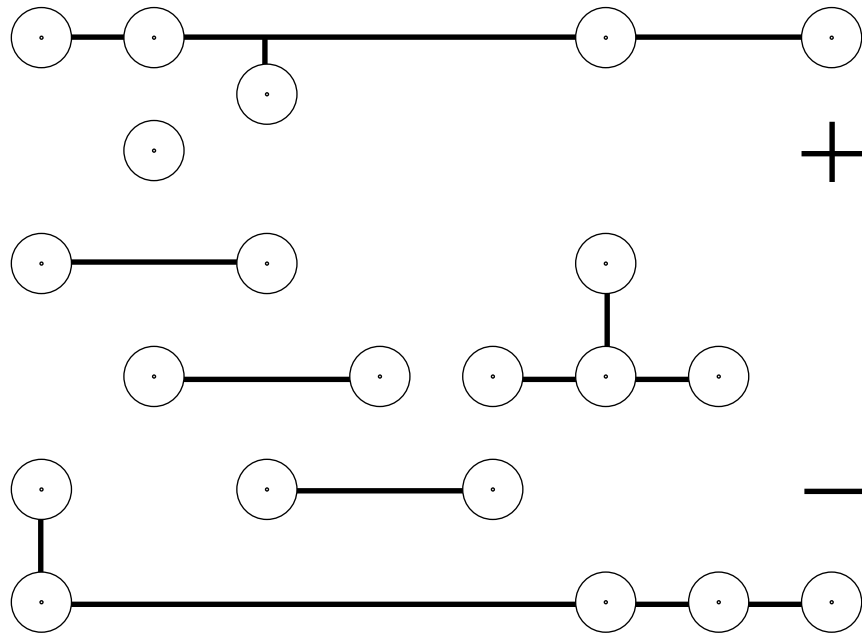

Passend zu Best.Nr. 10-807, 11-807, 12-807

Sirene

www.elmitron.de

Name: _____ Klasse: _____

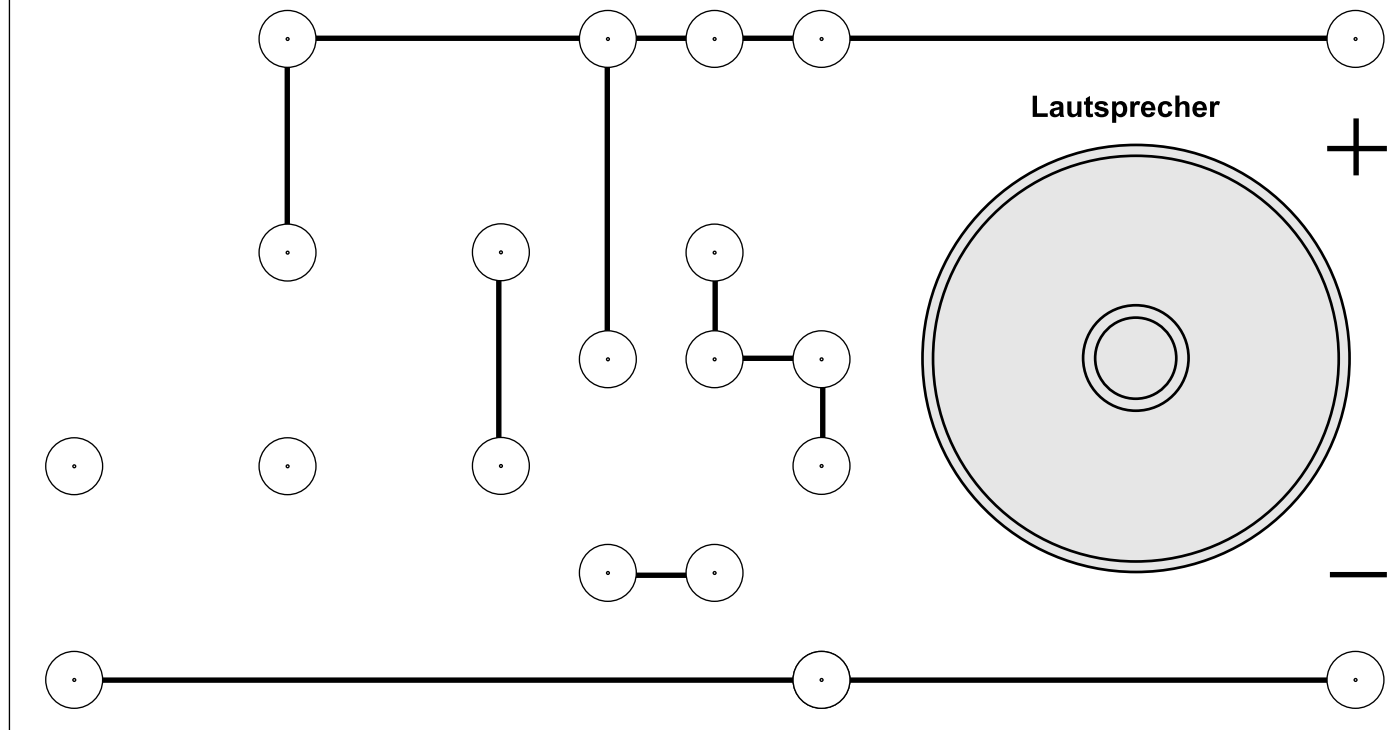

Passend zu Best.Nr. 10-808, 11-808, 12-808

Miniorgel

www.elmitron.de

Name: _____ Klasse: _____

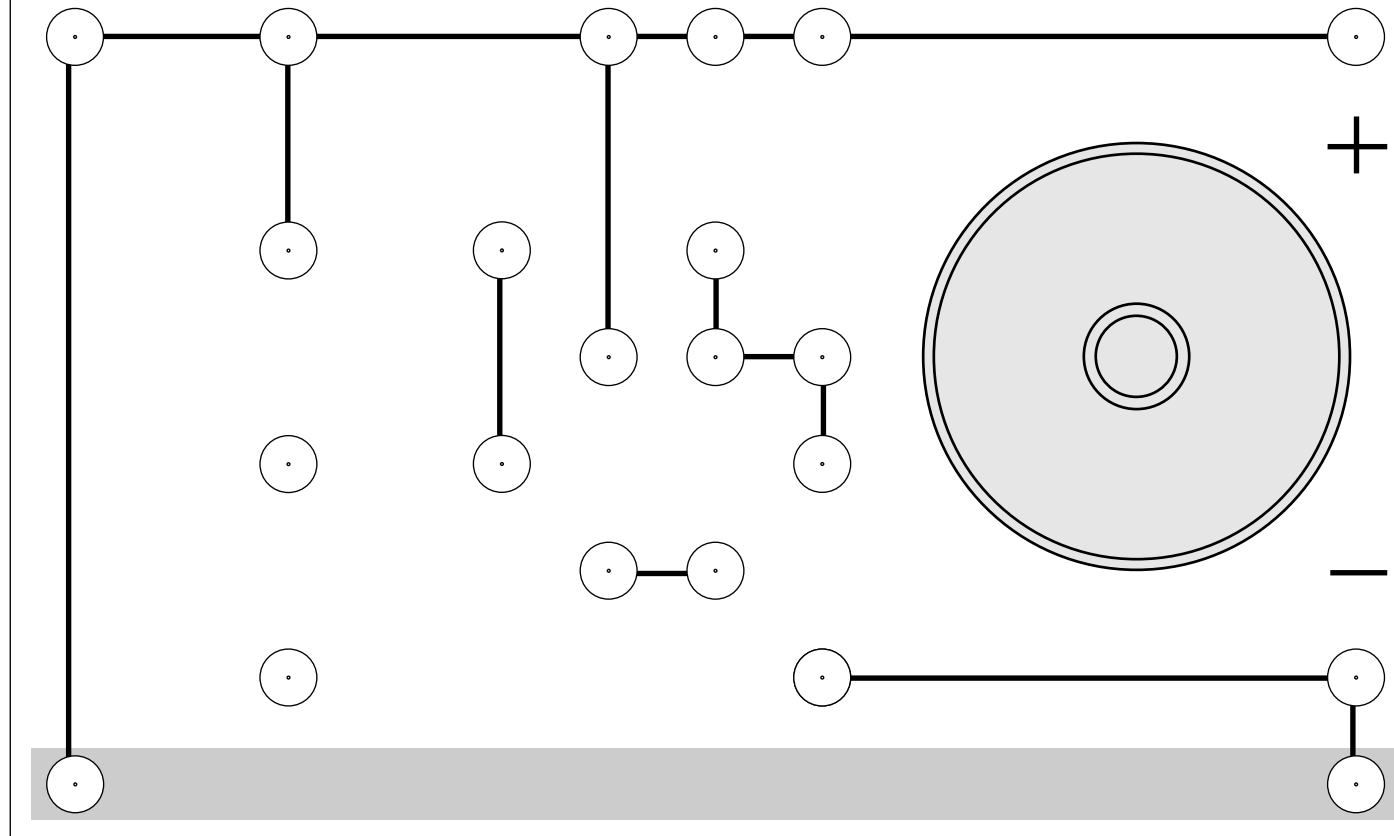

Passend zu Best.Nr. 10-809, 11-809, 12-809

Autohupe

Name: _____ Klasse: _____

www.elmitron.de

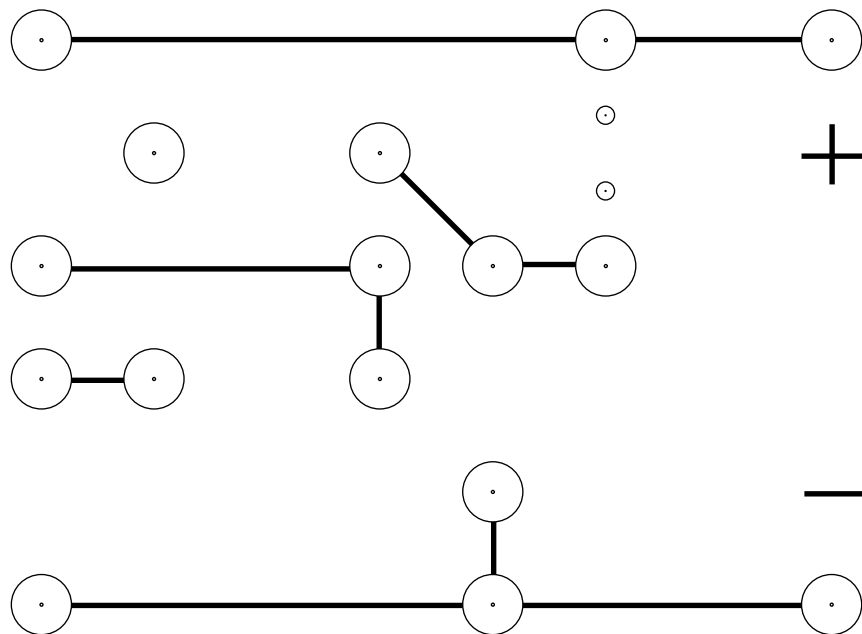

Passend zu Best.Nr. 10-810, 11-810, 12-810

4-Kanal-Lauflicht

Name: _____ Klasse: _____

www.ellmitron.de

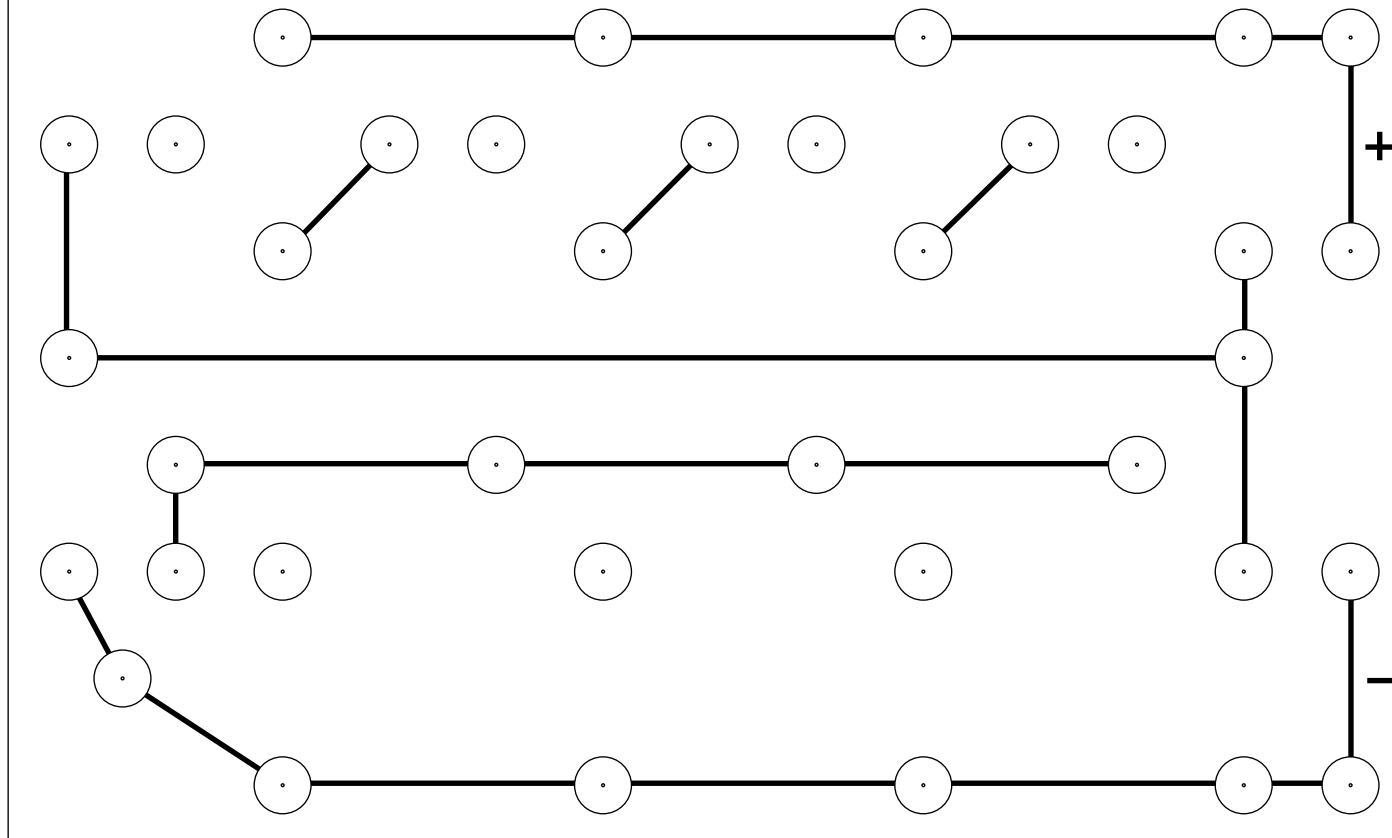

Passend zu Best.Nr. 10-811, 11-811, 12-811

LED-Verkehrsampel

Name: _____ Klasse: _____

www.ellmitron.de

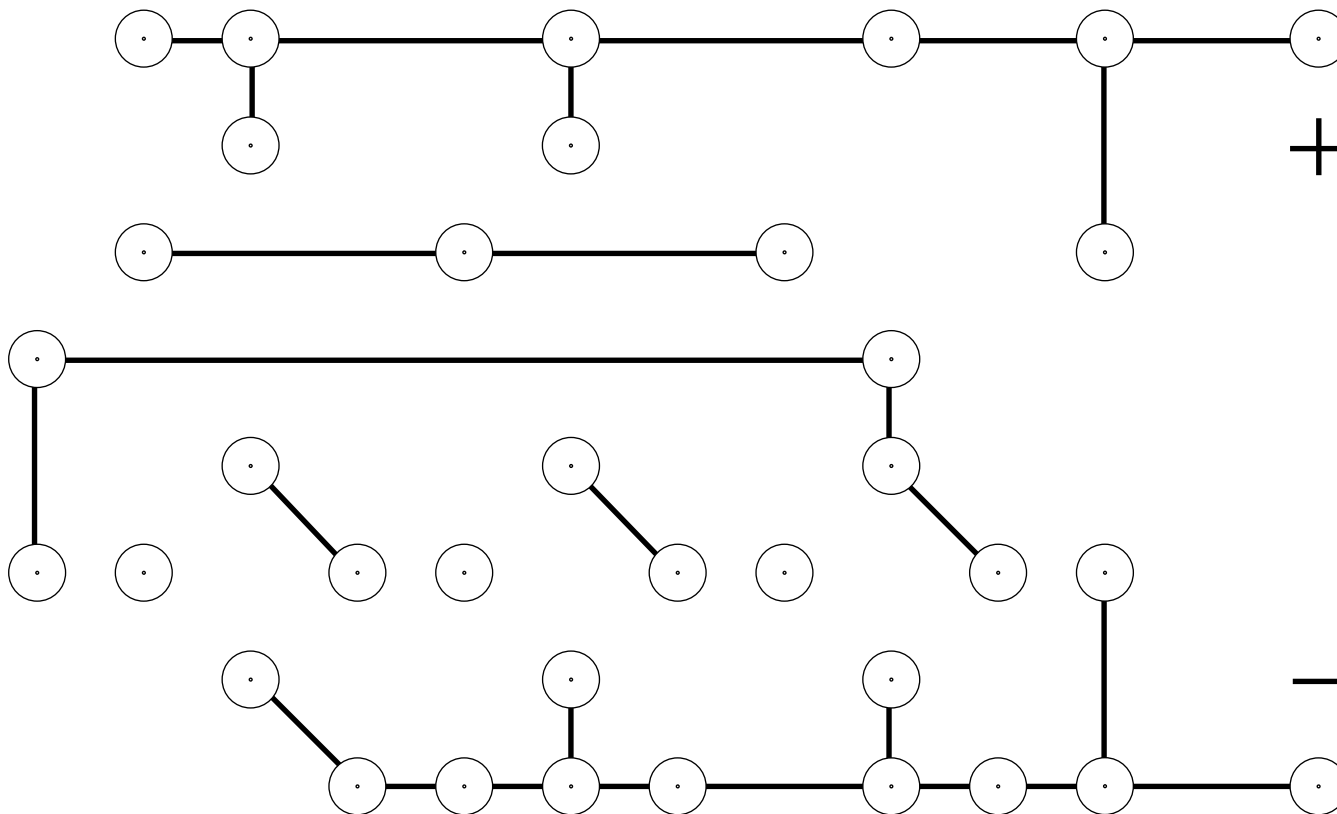

Passend zu Best.Nr. 10-812, 11-812, 12-812

Heulboje

www.elmitron.de

Name: _____ Klasse: _____

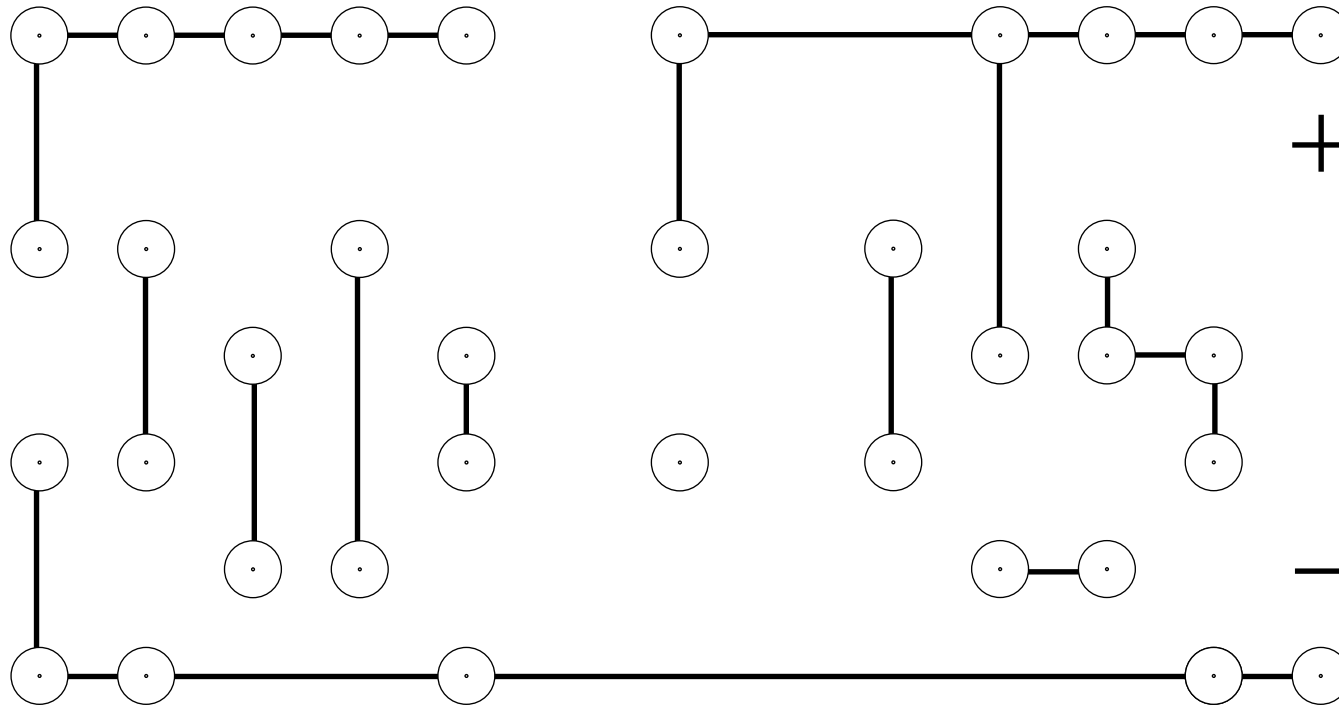

Passend zu Best.Nr. 10-813, 11-813, 12-813

Bewegungsmelder

Name: _____ Klasse: _____

www.ellmitron.de

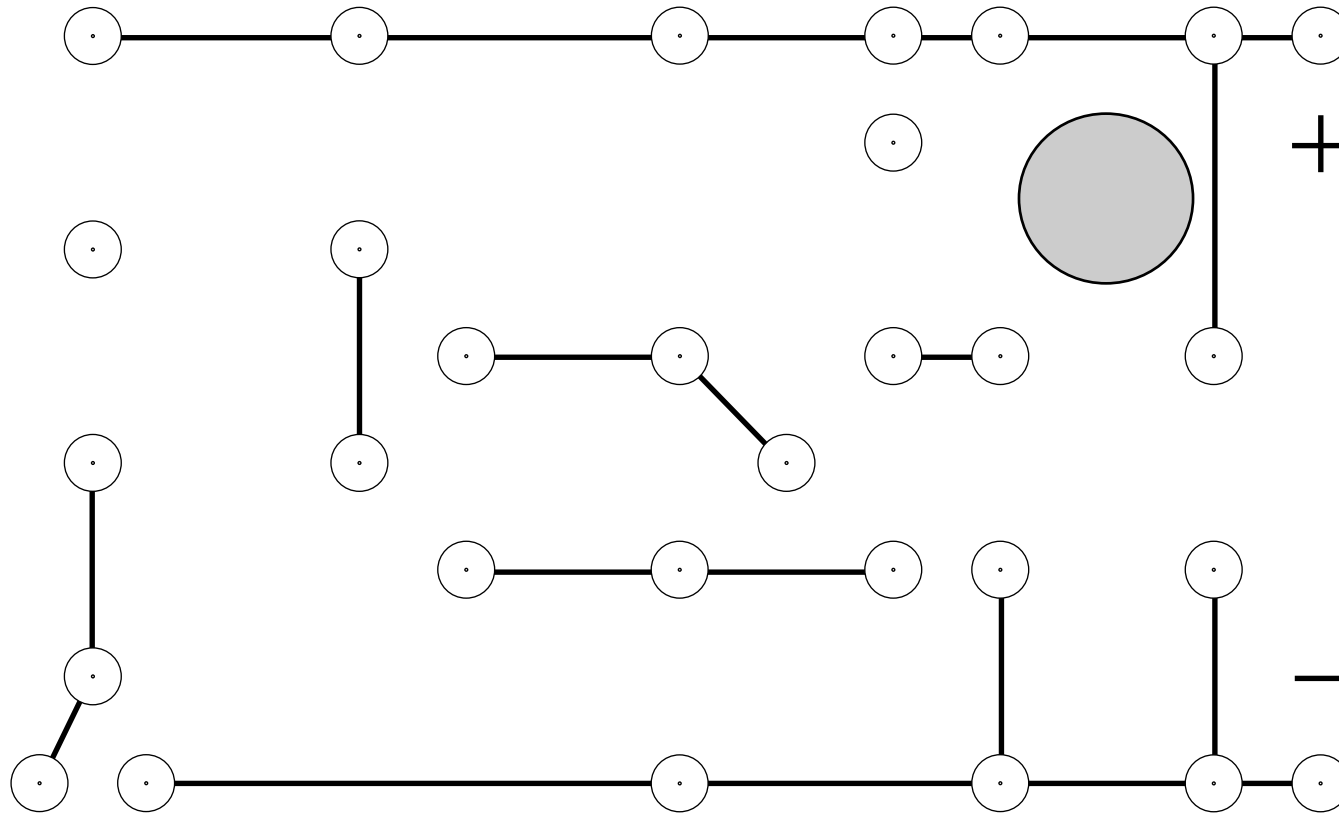

Passend zu Best.Nr. 10-814, 11-814, 12-814

Lernprogramm Teil 1

Name: _____ Klasse: _____

www.elmitron.de

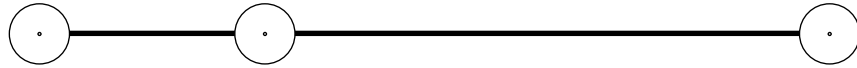

+



-

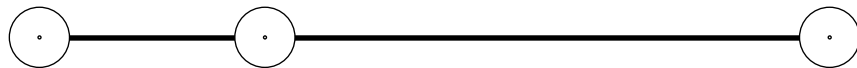

Passend zu Best.Nr. 10-815, 11-815

Lernprogramm Teil 2

Name: _____ Klasse: _____

www.elmitron.de

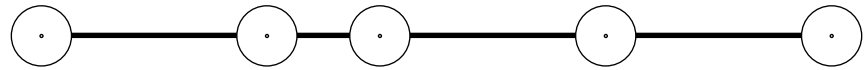

+

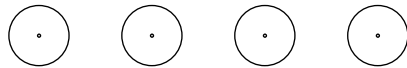
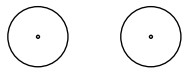

-

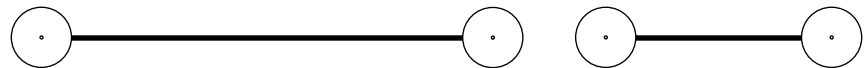

Lernprogramm Teil 3

Name: _____ Klasse: _____

www.elmitron.de

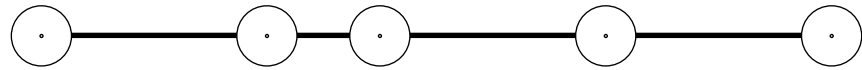

+

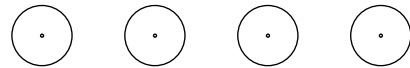
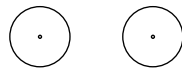

-

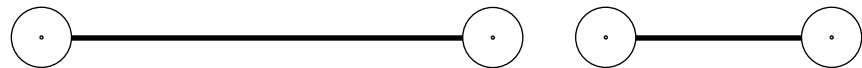

Lernprogramm Teil 4 - Opto-Elektronik

www.elmitron.de

Name: _____ Klasse: _____

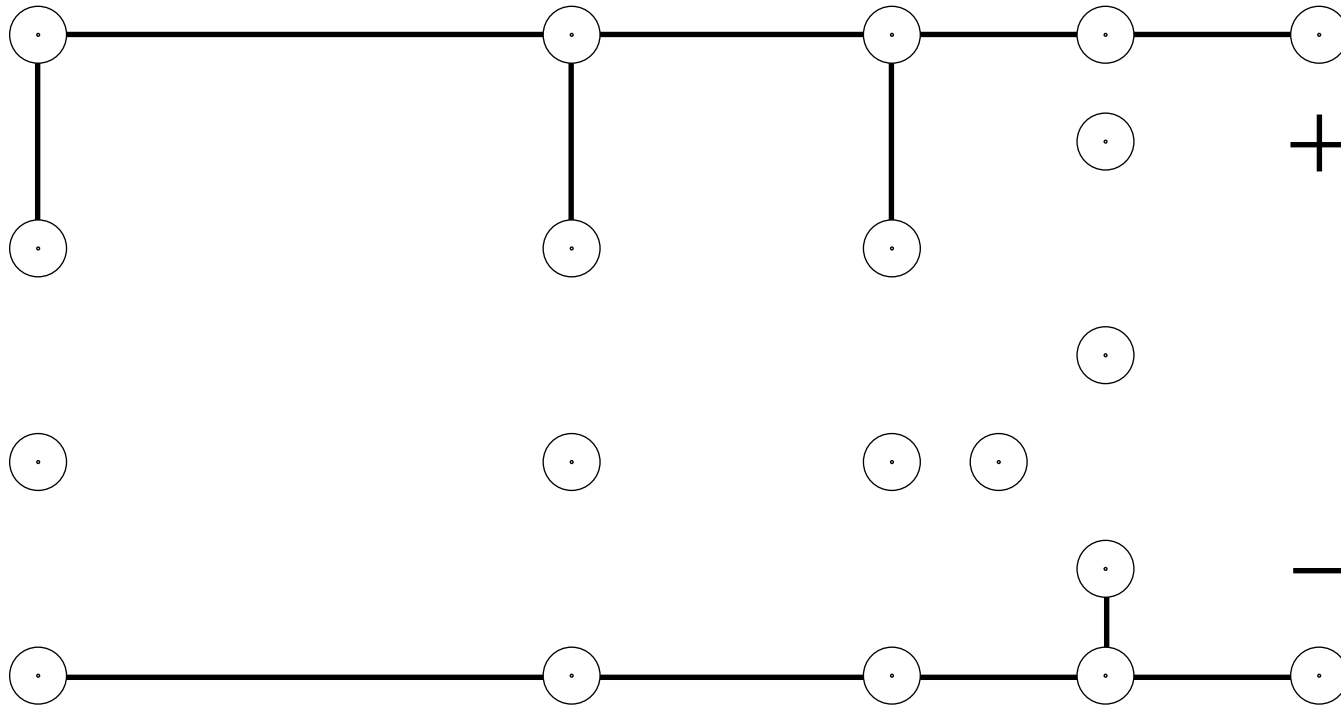

Passend zu Best.Nr. 10-818, 11-818

Lernprogramm Teil 5

Name: _____ Klasse: _____

www.elmitron.de

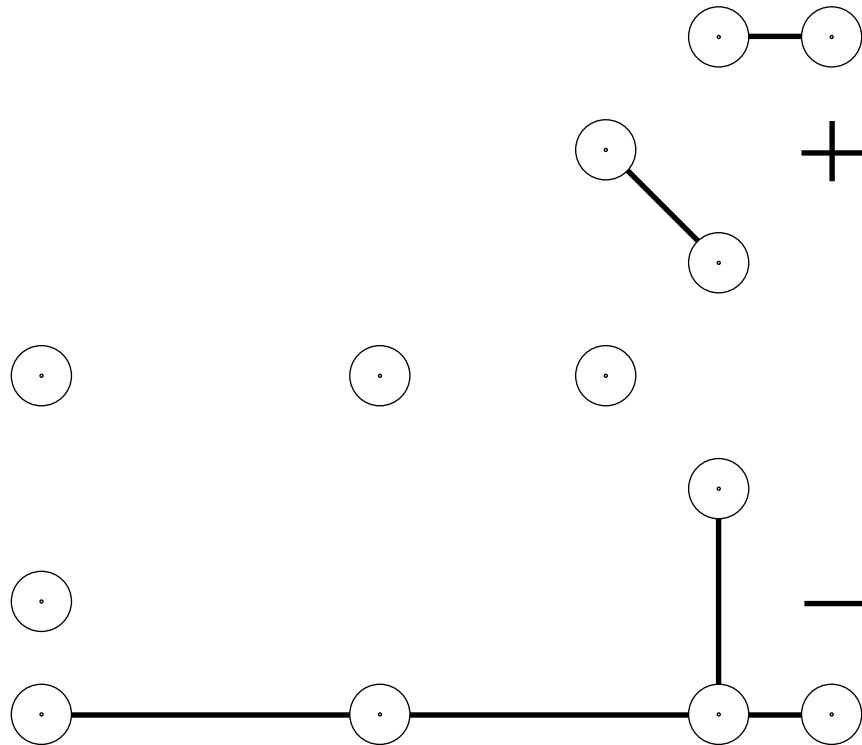

Lernprogramm Teil 6

Name: _____ Klasse: _____

www.elmitron.de

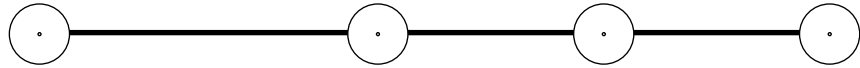

Lernprogramm Teil 8 - Digitaltechnik www.elmitron.de

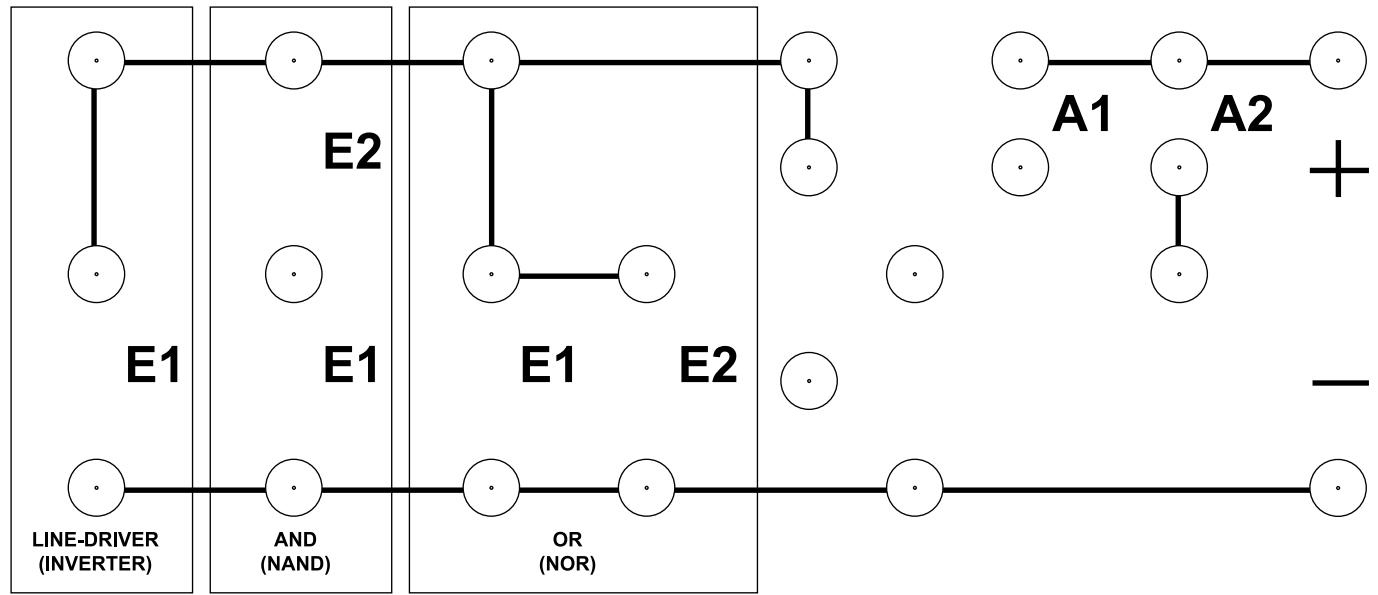

LINE-DRIVER			INVERTER			AND			NAND			OR			NOR		
E1	E2	A1	E1	E2	A2	E1	E2	A1	E1	E2	A2	E1	E2	A1	E1	E2	A2
L		L	L		H	L	L	L	L	L	H	L	L	L	L	L	H
H		H	H		L	H	L	L	H	L	H	H	L	H	H	L	L
						L	H	L	L	H	H	L	H	H	L	H	L
						H	H	H	H	H	L	H	H	H	H	H	L



Passend zu Best.Nr. 10-822, 11-822